

Disinfection Module Solution

### Specification

XMD-FBC-LLOA



## Product Brief

### Description

- This module is designed for disinfection.

### Features and Benefits

- Lead free product
- Push-in connectors
- Can be used in daisy chain configuration
- UL Compliant: E518993
- CE Tested to Standards:
  - EN55105 : 2013
  - EN61547 : 2009
  - EN62031 : 2008 + A1: 2013 + A2: 2015
  - EN62741 : 2008

### Key Applications

- Horticulture
- Reptile lighting
- Surface disinfection
- Fluorescent spectroscopy
- Chemical and biological analysis

Table 1. Product

Model	Input Current[ $I_i$ ]	$\Phi_e$ [mW]	Wp [nm]			Remark
			MIN	TYP	MAX	
XMD-FBC-LLOA	0.9A	414	270	275	280	Constant Current

# Table of Contents

Index	
• Product Brief	
• Table of Contents	
• Performance Characteristics	
• Drawing	
• Wire Guide	
• Packing	
• Label Information	
• Precaution for Use	

### Performance Characteristics

**Table 2. Electro Optical Characteristics at 0.9A(Constant Current)**

 (T<sub>a</sub>=25°C RH=30%)

Parameter	Symbol	Value			Unit
		Min.	Typ.	Max.	
Peak wavelength <sup>[1]</sup>	$\lambda_p$	270	275	280	nm
Forward Voltage	V <sub>F</sub>	20	24	27	V
Power Consumption	P	18	21.6	24.3	W
Radiant Flux <sup>[2]</sup>	$\Phi_e$ <sup>[3]</sup>	324	414	-	mW

**Notes :**

[1] P<sub>d</sub> can be changed by surrounding temperature and current.

[2] Peak Wavelength Measurement tolerance : ±3nm

[3] Radiant Flux Measurement tolerance : ± 10%

[4]  $\Phi_e$  is the Total Radiant Flux as measured with an integrated sphere.

[5] Forward Voltage Measurement tolerance : ±3%

※Operating temperature was tested at the assigned T<sub>c</sub> point on the PCB.

※It is recommended to drive under conditions of T<sub>c</sub>= 60 °C or less.

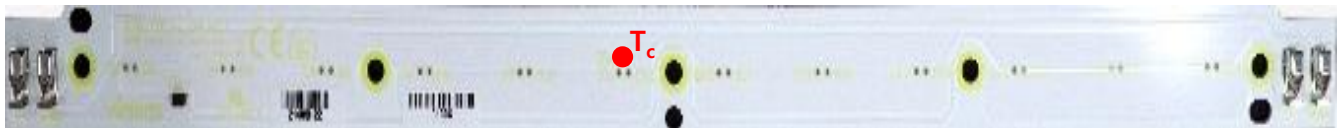
**Table 3. Absolute Maximum Ratings**

Parameter	Symbol	Unit	Value
Operating Temperature	T <sub>opr</sub>	°C	-20 ~ +40
Storage Temperature	T <sub>stg</sub>	°C	-20 ~ +60

### Drawing

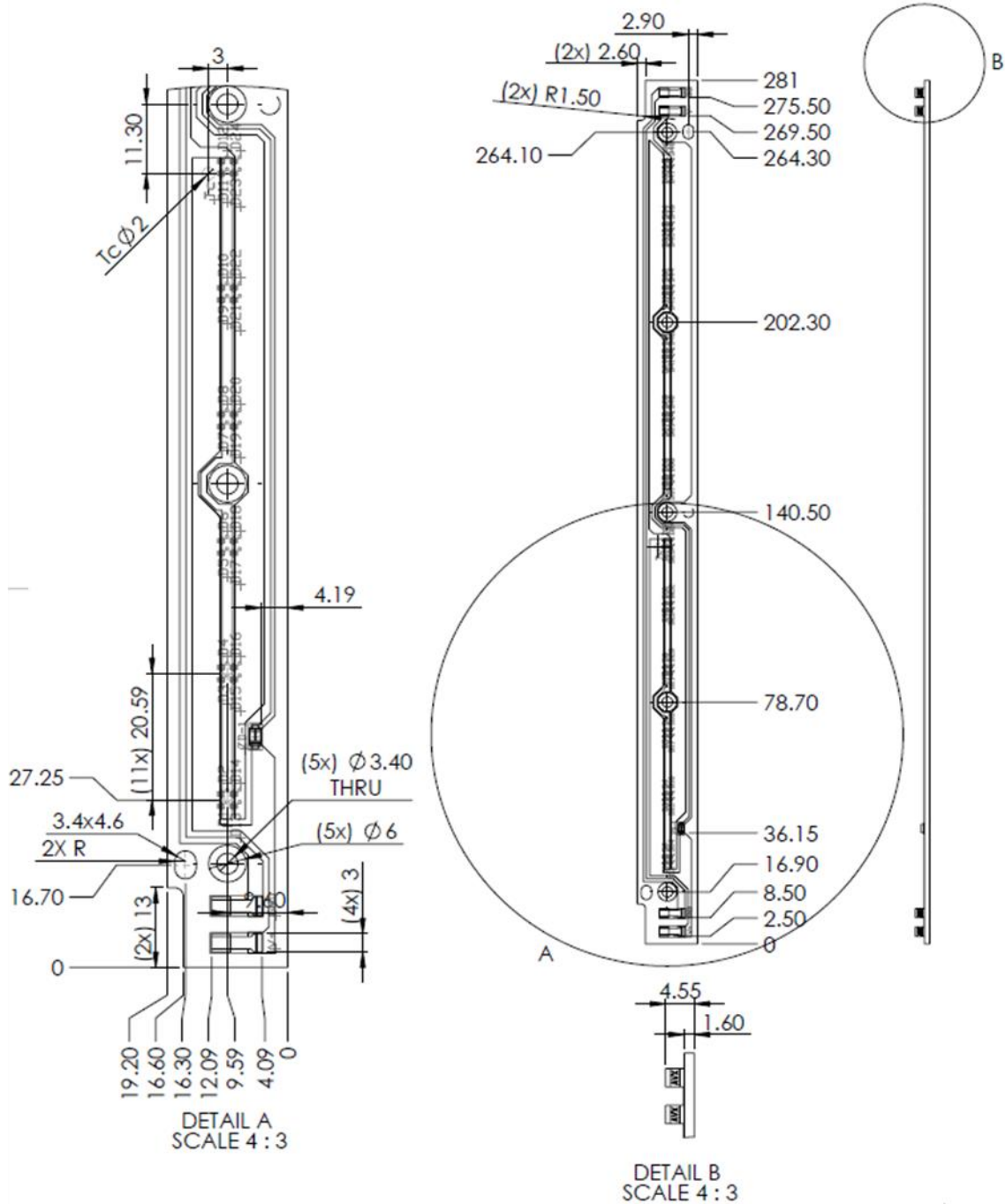

- (1) All dimensions are in mm
- (2) For reference only
- (3) Not to scale

For 4 LED clusters – clusters on centerline  
 For 2 LED clusters – All LEDs on centerline  
 For 1 LED clusters – LED at cluster center  
 Recommended fasteners: M3 pan head

#### Notes :

- Module Dimensions of the indicated maximum value, and to allow a tolerance : ±0.5 [mm]

## Wire Guide

### WARNING: DO NOT WIRE MORE THAN 9 BOARDS IN SERIES

#### Notes:

- Tool to open the contact to Insert/withdraw wire.  
Contact opening tool [P/N : 06-9296-7001-01-000]
- Wire Size : 18AWG to 26AWG [solid/stranded copper conductor.]
- Wire Trim Length :  $4.5 \pm 0.5\text{mm}$  [AVX Connector]

#### Single Board



For terminating end:  
V- to GND

#### Multiple Boards

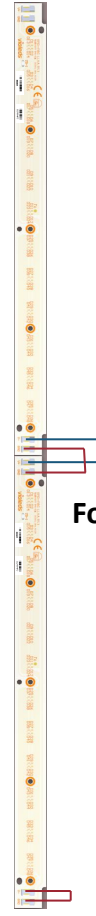

For all junctions:  
V- to V+  
GND to GND

For terminating end:  
V- to GND

### Packing

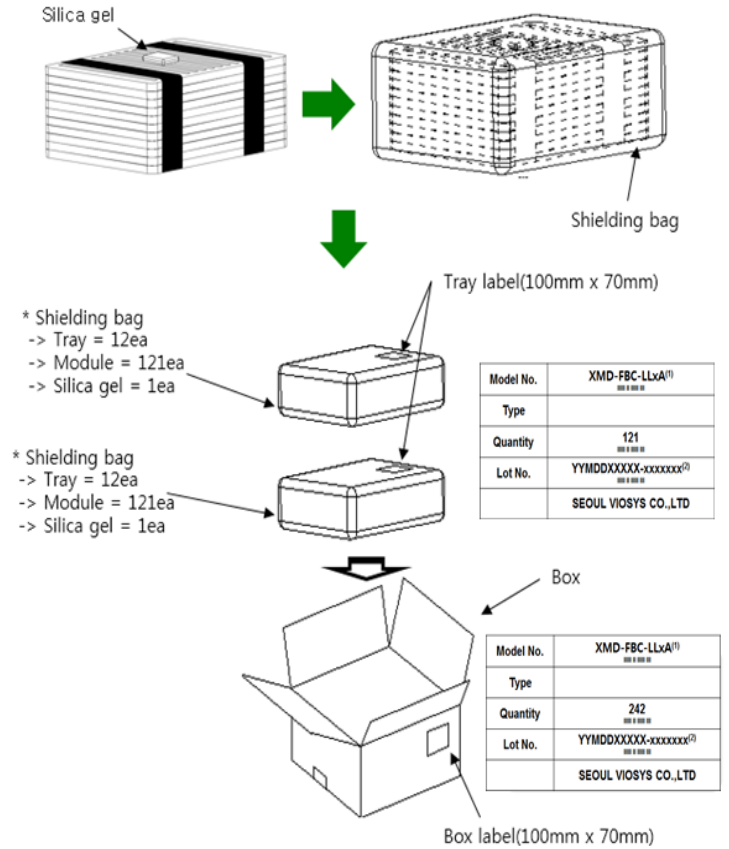
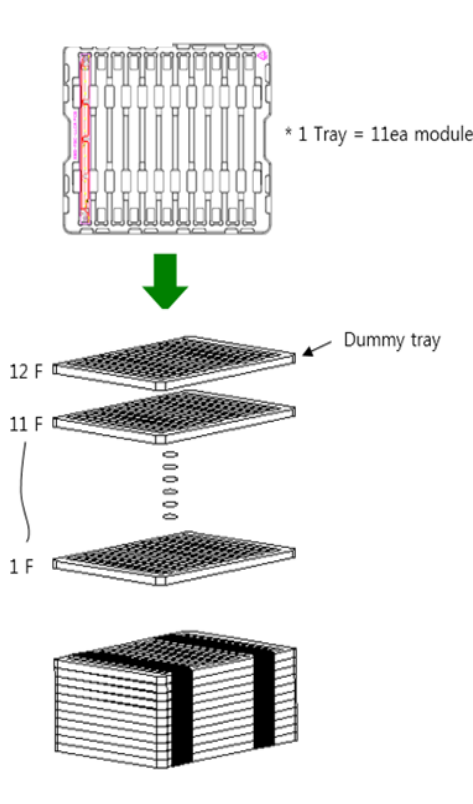

Part	Index	Unit	XMD-FBC-LLCA	Remark
Tray	Size	mm	380 X 315 X 14	
	Module Quantity	ea	11	
	Weight	kg	0.17	Without LED Module
		Kg	0.44	With LED module
BOX	Size	mm	407 X 333 X 280	
	Tray Quantity	Ea	22(+2Dummy)	
	Module Quantity	ea	242	
	Material	-	Anti-static PET	
	Weight	kg	10.5	With LED module
Pallet	Size	mm	1100(L) X 1100(W)	
	Box quantity	ea	32	8 Box X 4 Layer
	Weight	kg	5	Only Pallet
Total	Module quantity	ea	7,744	
	Weight	kg	350	With LED module

### Label Information

**Fig 1. Marking point**

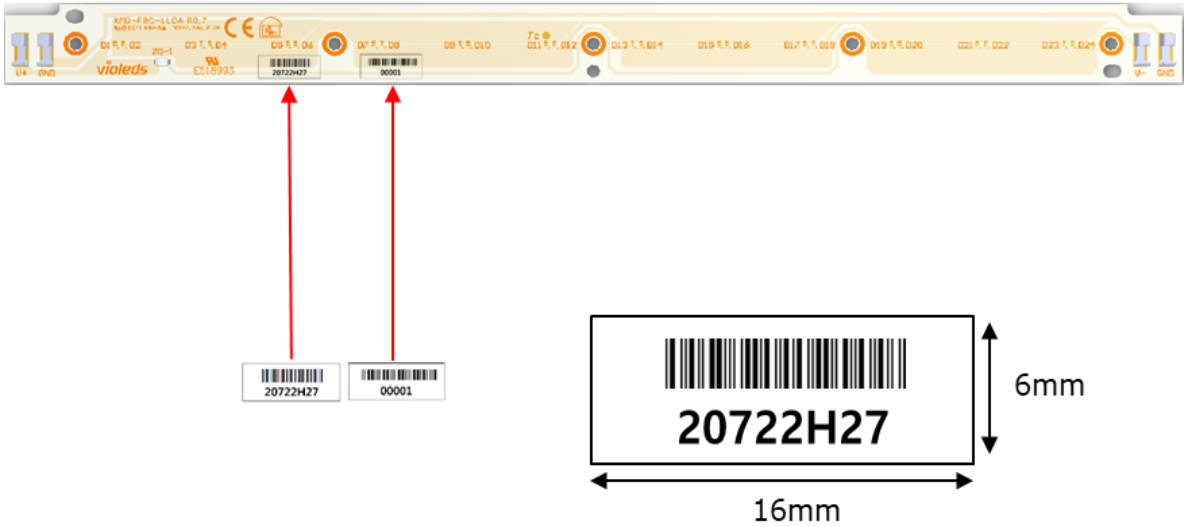

**Fig 2. Marking information**

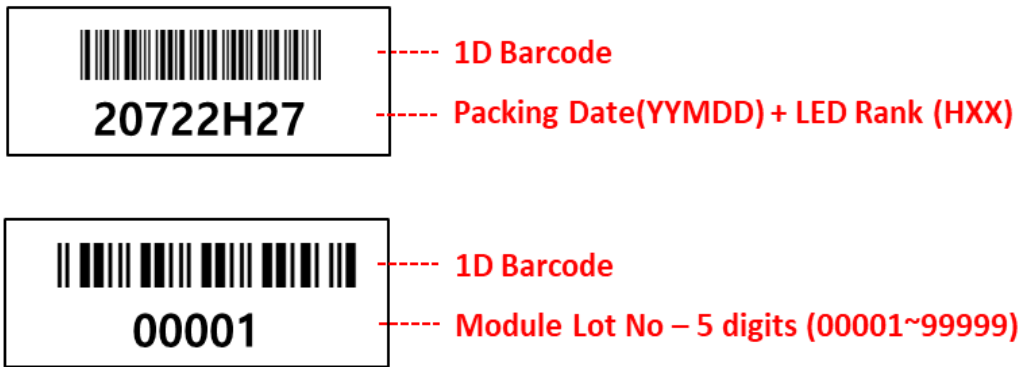

**Notes**

- 1) Refer to the page 11 for Packing Date

### Label Information

<b>Model No.</b>	<b>XMD-FBx-LLxA<sup>(1)</sup></b> 
<b>Type</b>	
<b>Quantity</b>	<b>XXX</b> 
<b>Lot No.</b>	<b>YYMDDXXXXX-xxxxxxx<sup>(2)</sup></b> 
	<b>SEOUL VIOSYS CO.,LTD</b>

### Reference

- (1) It represent module part number.
- (2) YYMDD : Packing Date  
 YY : last 2digits of year(ex – 2018 → 18)  
 M : Oct-A, Nov-B, Dec-C(1digits)  
 DD : Date(2digits)  
 X : Initial of Manufacturer(1digits)  
 XXXX : Sealing Pack No(4digits)  
 - : dash  
 XXXXXXX : SSC Code(7digits)

### Note

- (1) It is attached to the top right corner of the box.

### \* Labeling

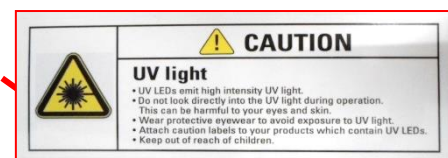
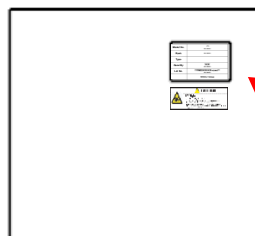



## Precaution for Use

### 1) Storage

- To avoid moisture penetration, we recommend storing UV-Module in a dry box with a desiccant. The recommended temperature and Relative humidity are between 5°C and 30°C and below 50% respectively.
- UV-Module must be stored properly to maintain the device. If the UV-Module is stored for 3 months or more after being shipped from SVC, a sealed container with a nitrogen atmosphere should be used for storage.
- Replace the remained UV-Module into the moisture-proof bag and reseal the bag after work to avoid those UV-Module being exposed to moisture. Prolonged exposure to moisture can adversely affect the proper functioning of the UV-Module.

### 2) Handling Precautions

- VOCs (Volatile organic compounds) emitted from materials used in the construction of fixtures can penetrate products and discolor them when exposed to heat and photonic energy. The result can be a significant loss of light output from the fixture. Knowledge of the properties of the materials selected to be used in the construction of fixtures can help prevent these issues.
- In case of attaching UV-Module, do not use adhesives that outgas organic vapor.
- Please do not use(or storage) together with the materials containing Sulfur.
- Do not use inflammable material nearby the products.
- Do not touch the products with wet hand
- Do not fix or remodel the products.
- Do not drop the machine, or give strong impact on the products.
- The UV-Module is encapsulated with special material for the highest flux efficiency. So it needs to be handled carefully as below
  - Avoid touching quartz glass parts especially with sharp tools such as Tweezers
  - Avoid leaving fingerprints cover parts.
  - UV-Module will attract dust so use covered containers for storage.
  - It is not recommend to cover the UV-Module with other materials (epoxy, urethane, etc)

### 3) Safety for eyes and skin

- The Products emit high intensity ultraviolet light which can make your eyes and skin harmful, So do not look directly into the UV light and wear protective equipment during operation.

### 4) Cleaning

- After assembly the product, empty the water and then wipe the UV-Module with a dry towel.

## Precaution for Use

### 5) Others

- Be sure to turn On / Off after module is connected.  
When connecting the module in the power on state, LED can be damaged by the influence of the inrush voltage / current.
- The driving circuit must be designed to allow forward voltage or current only when it is ON or OFF . If the reverse voltage is applied to UV-Module, migration can be generated resulting in LED damage.
- Do not handle this product with acid or sulfur material in sealed space
- Please handle using equipment that prevents static electricity.
- Do not touch unless ESD protection is used.
- Ionizer, grounding and keeping appropriate humidity are necessary for work environment.
- The appearance and specifications of the product may be modified for improvement without notice

